

1. Features

- n $R_{DS(on)}=14.5m\Omega(\text{typ}) @ V_{GS}=10\text{ V}$
- n Super low gate charge
- n Green device available
- n Excellent Cdv/dt effect decline
- n Advanced high cell density trench technology

2. Description

The KIA4603A is the high cell density trenched N-ch MOSFETs, which provide excellent RDSON and gate charge for most of the synchronous buck converter applications. The KIA4603A meet the RoHs and Green Product requirement.

3. Symbol

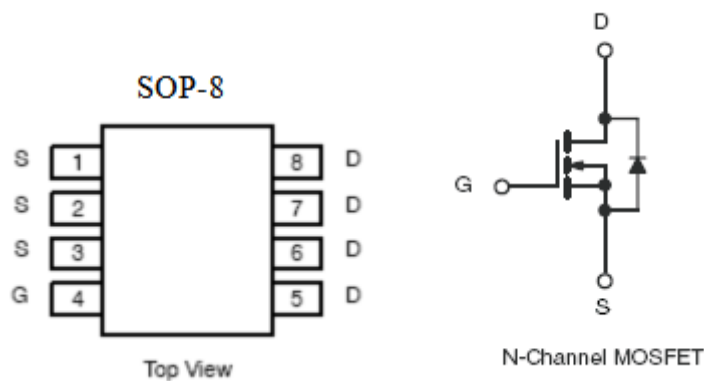

4. Absolute maximum ratings

($T_A=25^\circ\text{C}$, unless otherwise noted)

Parameter	Symbol	Rating	Units
Drain-source voltage	V_{DSS}	30	V
Gate-source voltage	V_{GS}	± 20	V
Continuous drain current $V_{GS}@10V^1$	I_D	$T_A=25^\circ\text{C}$	7.0
		$T_A=70^\circ\text{C}$	5.6
Pulsed drain current ²	I_{DM}	35	A
Single pulse avalanche energy ³	EAS	20	mJ
Avalanche current	I_{AS}	20	A
Total power dissipation ⁴	P_D	1.5	W
Junction and storage temperature range	T_J, T_{STG}	-55 to 150	$^\circ\text{C}$
Thermal resistance-junction to ambient ¹	$R_{\theta JA}$	85	$^\circ\text{C/W}$
Thermal resistance-junction to case ¹	$R_{\theta JC}$	25	$^\circ\text{C/W}$

5. Electrical characteristics

(T_J=25°C, unless otherwise noted)

Parameter	Symbol	Test Conditions	Min	Typ	Max	Units
Drain-Source breakdown voltage	BV _{DSS}	V _{GS} =0V, I _D =-250μA	30	-	-	V
BV _{DSS} Temperature coefficient	$\frac{\Delta BV_{DSS}}{\Delta T_J}$	Reference to 25°C, I _D =1mA	-	0.034	-	V/°C
Drain-Source Leakage Current	I _{DSS}	V _{DS} =24V, V _{GS} =0V, T _J =25°C	-	-	1	μA
		V _{DS} =24V, V _{GS} =0V, T _J =55°C	-	-	5	
Gate-source leakage current	I _{GSS}	V _{GS} =±20V, V _{DS} =0V	-	-	±100	nA
Gate threshold voltage	V _{GS(th)}	V _{DS} =V _{GS} , I _D =250μA	1.2	1.5	2.5	V
V _{GS(th)} Temperature coefficient	$\Delta V_{GS(th)}$		-	3.84	-	mV/°C
Static drain-source on- resistance ²	R _{DS(on)}	V _{GS} =10V, I _D =7A	-	14.5	18	mΩ
		V _{GS} =4.5V, I _D =4A	-	20	26	
Forward transconductance	g _{FS}	V _{DS} =5V, I _D =7A	-	6.2	-	S
Diode forward voltage ²	V _{SD}	V _{GS} =0V, I _S =1A, T _J =25°C	-	-	1.2	V
Gate resistance	R _g	V _{DS} =0V, V _{GS} =0V, f=1MHz	-	1.04	-	Ω
Total gate charge(4.5V)	Q _g	V _{DS} =15V, V _{GS} =4.5V I _D =7A	-	6	-	nC
Gate-source charge	Q _{gs}		-	2.2	-	
Gate-drain charge	Q _{gd}		-	2	-	
Turn-on delay time	t _{d(on)}	V _{DD} =15V, R _G =3.3Ω, V _{GS} =10V I _D =7A	-	1.2	-	ns
Rise time	t _r		-	40	-	
Turn-off delay time	t _{d(off)}		-	18	-	
Fall time	t _f		-	7.2	-	
Input capacitance	C _{iss}	V _{GS} =0V, V _{DS} =15V F=1.0MHZ	-	583	-	pF
Output capacitance	C _{oss}		-	77	-	
Reverse transfer capacitance	C _{rss}		-	59	-	
Diode characteristics						
Continuous source current ^{1,5}	I _S	V _G =V _D =0V, Force current	-	-	7	A
Pulsed source current ^{2,5}	I _{SM}		-	-	35	A
Reverse recovery time	t _{rr}	I _F =7A, di/dt=100A/us, T _J =25°C	-	7.2	-	nS
Reverse recovery charge	Q _{rr}		-	2.9	-	nC

Note:1. The data tested by surface mounted on a 1 inch² FR-4 board with 2OZ copper.

2. The data tested by pulsed, pulse width ≤300us, duty cycle ≤2%.

3. The EAS data shows Max.rating. The test condition is V_{DD}=25V, V_{GS}=10V, L=0.1mH. I_{AS}=20A.

4. The power dissipation is limited by 150 °C junction temperature.

5. The data is theoretically the same as I_D and I_{DM}, in real applications, should be limited by total power dissipation.

6. Test circuits and waveforms

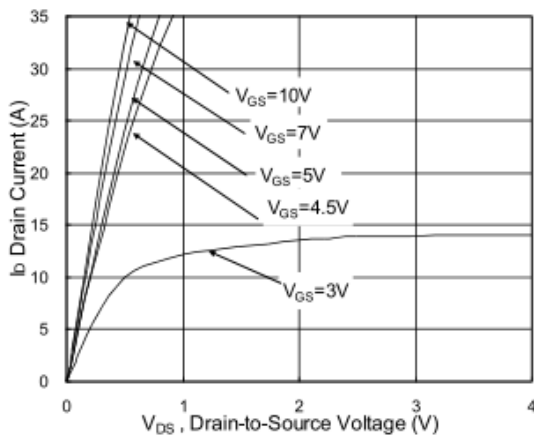

Fig.1 Typical Output Characteristics

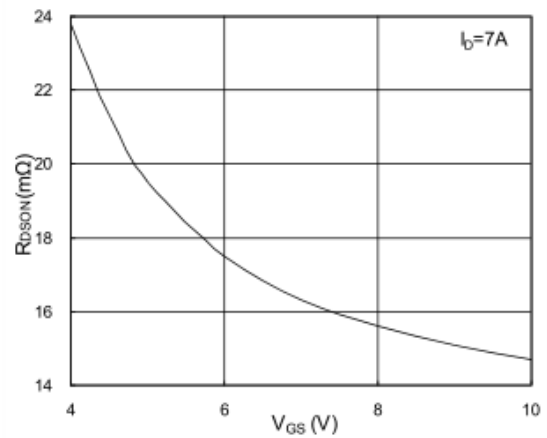

Fig.2 On-Resistance vs. Gate-Source

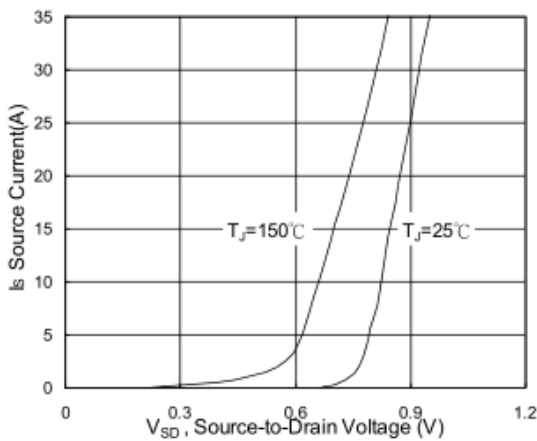

Fig.3 Forward Characteristics Of Reverse

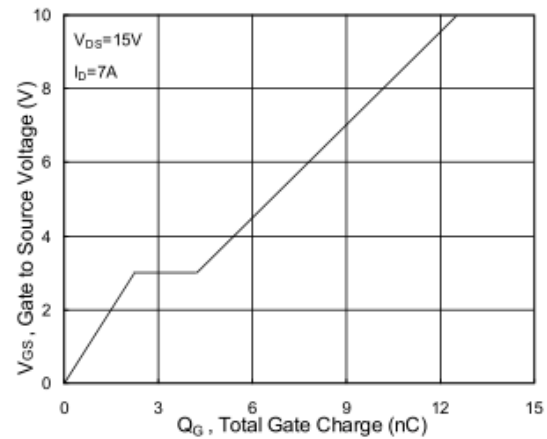

Fig.4 Gate-Charge Characteristics

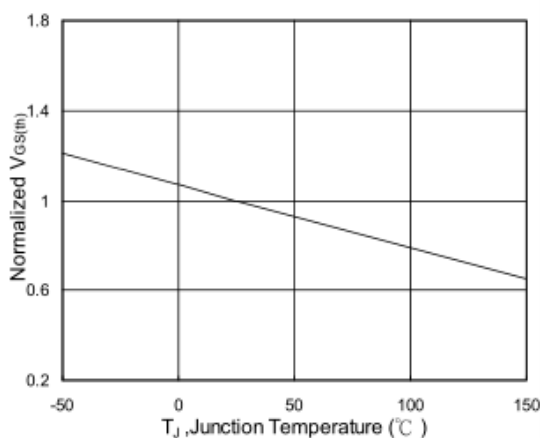

Fig.5 Normalized $V_{GS(th)}$ vs. T_J

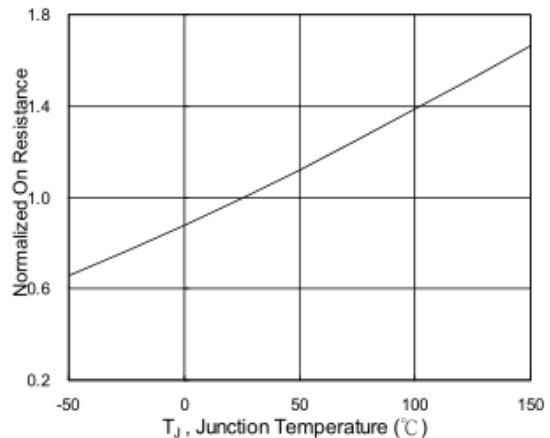

Fig.6 Normalized $R_{DS(on)}$ vs. T_J

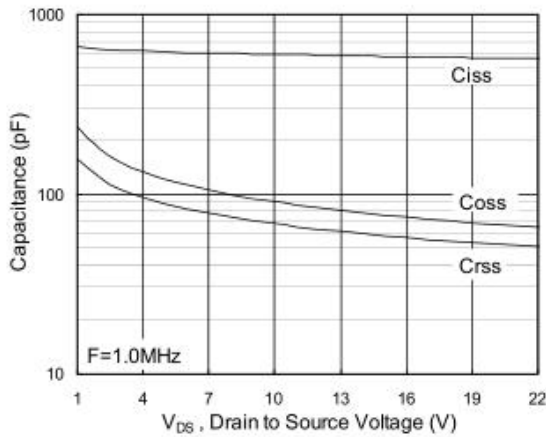

Fig.7 Capacitance

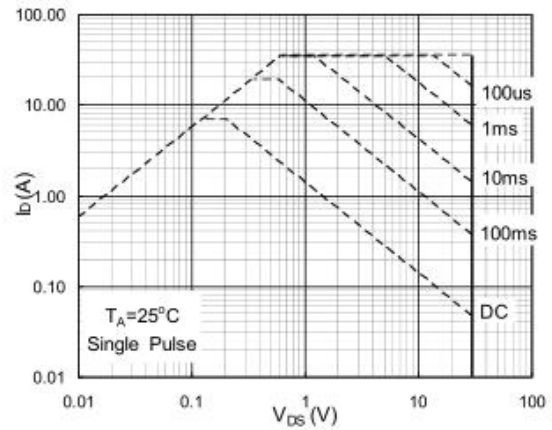

Fig.8 Safe Operating Area

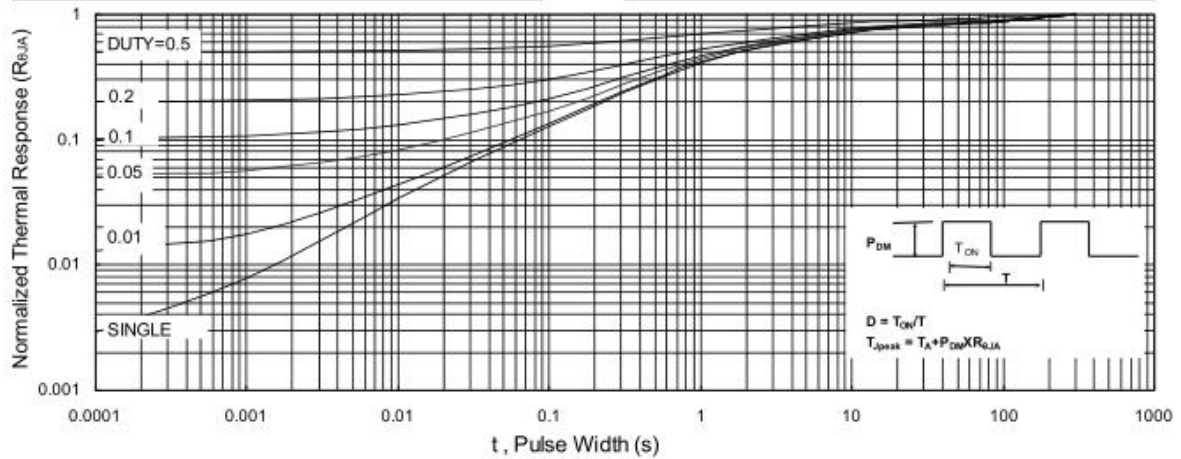

Fig.9 Normalized Maximum Transient Thermal Impedance

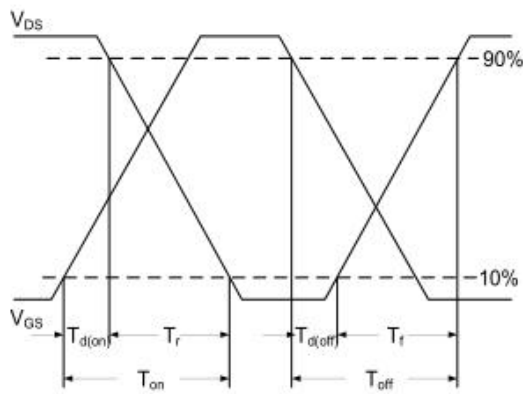

Fig.10 Switching Time Waveform

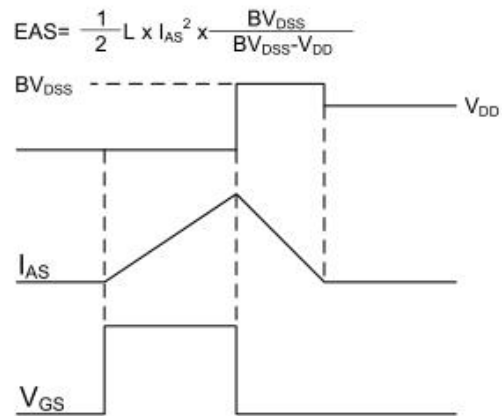

Fig.11 Unclamped Inductive Switching Waveform