

1. Features

- n $R_{DS(on)}=4.5m\Omega @ V_{GS}=10V$
- n Lead free and Green Device Available
- n Low Rds-on to Minimize Conductive Loss
- n High avalanche Current

2. Application

- n Load Switch
- n SMPS

3. Pin configuration

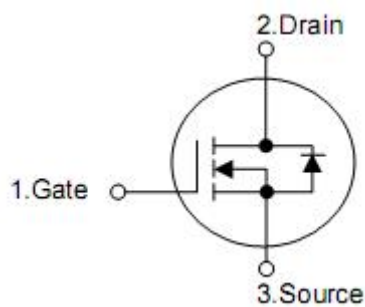
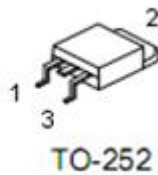

Pin	Function
1	Gate
2	Drain
3	Source

4. Ordering Information

Part Number	Package	Brand
KND3403A	TO-252	KIA

5. Absolute maximum ratings

TC=25 °C unless otherwise specified

Parameter		Symbol	Ratings	Unit
Drain-to-Source Voltage		V_{DSS}	30	V
Gate-to-Source Voltage		V_{GSS}	±20	
Continuous Drain Current	$T_C=25\text{ °C}$ (Silicon limited)	I_D $V_{GS}=10V$	85	A
	$T_C=100\text{ °C}$ (Silicon limited)		61	
	$T_C=25\text{ °C}$ (Package limited)		50	
	$T_C=25\text{ °C}$ (Silicon limited)	I_D $V_{GS}=4.5V$	76	
	$T_C=100\text{ °C}$ (Silicon limited)		54	
	$T_C=25\text{ °C}$ (Package limited)		50	
Pulsed Drain Current Tested	$T_C=25\text{ °C}$ (Silicon Limit)	I_{DM}	340	
Avalanche Current (L=0.5mH)		I_{AS}	25	A
Avalanche Energy (L=0.5mH)		E_{AS}	156	mJ
Maximum power Dissipation	$T_C=25\text{ °C}$	P_D	71	W
	$T_C=100\text{ °C}$		35	
Junction & Storage Temperature Range		T_J & T_{STG}	-55 to 175	°C

6. Thermal characteristics

Parameter	Symbol	Ratings	Units
Thermal resistance, junction-ambient	$R_{\theta JA}$	2.1	°C/W
Thermal resistance, Junction-case	$R_{\theta JC}$	106	

7. Electrical characteristics

($T_J=25^{\circ}\text{C}$, unless otherwise notes)

Parameter	Symbol	Conditions	Min	Typ	Max	Units
Static characteristics						
Drain-source breakdown voltage	BV_{DSS}	$V_{GS}=0V, I_D=250\mu A$	30	-	-	V
Zero Gate Voltage Drain Current	I_{DSS}	$V_{DS}=24V, V_{GS}=0V$	-	-	1	μA
Gate threshold voltage	$V_{GS(th)}$	$V_{DS}=V_{GS}, I_D=250\mu A$	0.8	-	2.0	V
Gate leakage current	I_{GSS}	$V_{GS}=\pm 20V, V_{DS}=0V$	-	-	± 100	nA
Drain-source on-resistance	$R_{DS(on)}$	$V_{GS}=10V, I_D=30A$	-	4.5	5.5	m Ω
		$V_{GS}=4.5V, I_D=30A$	-	5.5	7	
Forward Transconductance	g_{fs}	$V_{DS}=5V, I_D=90A$	-	74	-	S
Dynamic characteristics						
Gate Resistance	R_G	$V_{GS}=0V, V_{DS}=0V$ Frequency=1MHz	-	2.0	-	Ω
Input capacitance	C_{iss}	$V_{DS}=15V, V_{GS}=0V,$ $F=1MHz$	-	3000	-	pF
Output capacitance	C_{oss}		-	330	-	pF
Reverse transfer capacitance	C_{rss}		-	285	-	pF
Turn-on delay time	$t_{d(on)}$	$V_{DS}=15V, I_D=1A,$ $V_{GS}=4.5V, R_G=3\Omega$	-	20	-	ns
Rise time	t_r		-	32	-	ns
Turn-off delay time	$t_{d(off)}$		-	60	-	ns
Fall time	t_f		-	33	-	ns
Gate Charge Characteristics						
Total gate charge	Q_g	$V_{DS}=25V, I_D=14A,$ $V_{GS}=4.5V$	-	25	-	nC
Gate-source charge	Q_{gs}		-	3.2	-	nC
Gate-drain charge	Q_{gd}		-	12	-	nC
Diode characteristics						
Diode forward voltage	V_{SD}	$V_{GS}=0V, I_{SD}=25A$	-	0.82	1.3	V
Drain Continuous Forward current	I_S		-	-	50	A
Reverse recovery time	t_{rr}	$I_S=20A$ $di/dt=100A/\mu s$	-	14	-	ns
Reverse recovery charge	Q_{rr}		-	2.8	-	μC

8. Typical Characteristics

Figure 1. Typ. Output Characteristics

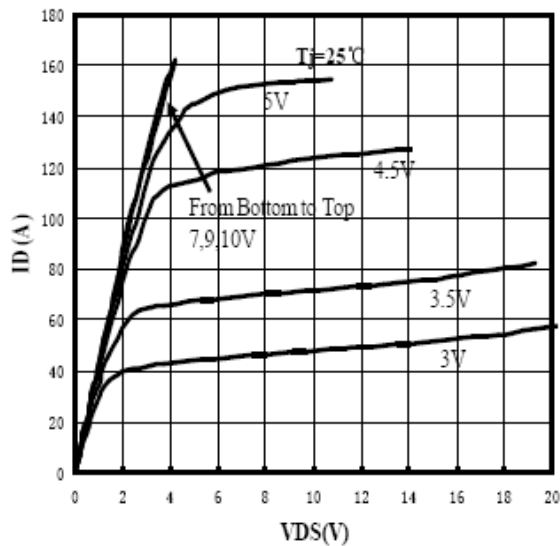

Figure 2. Typ. Output Characteristics

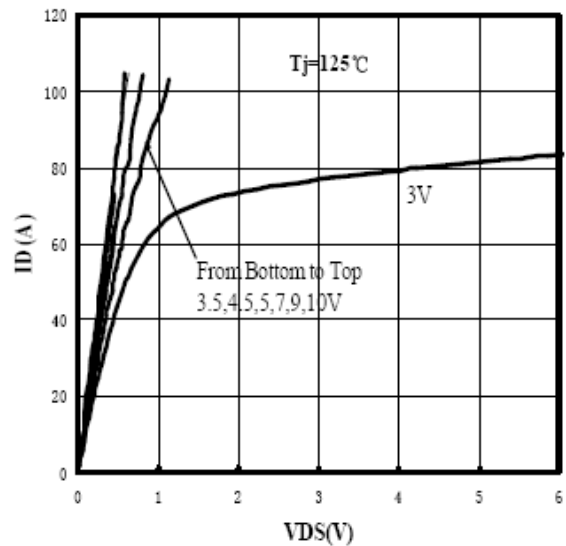

Figure 3. Transfer Characteristics

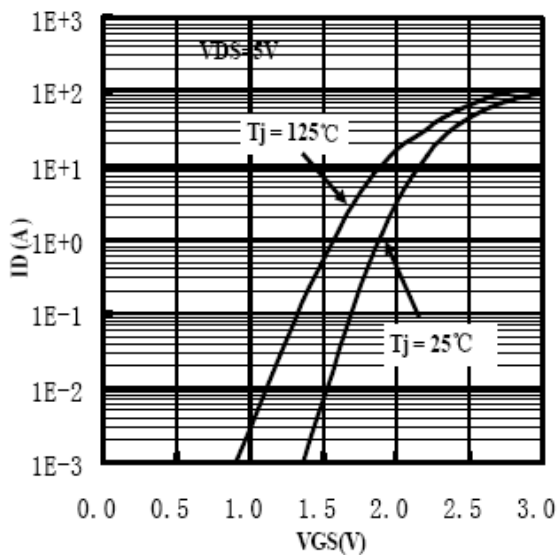

Figure 4. Gate Threshold Voltage Characteristics

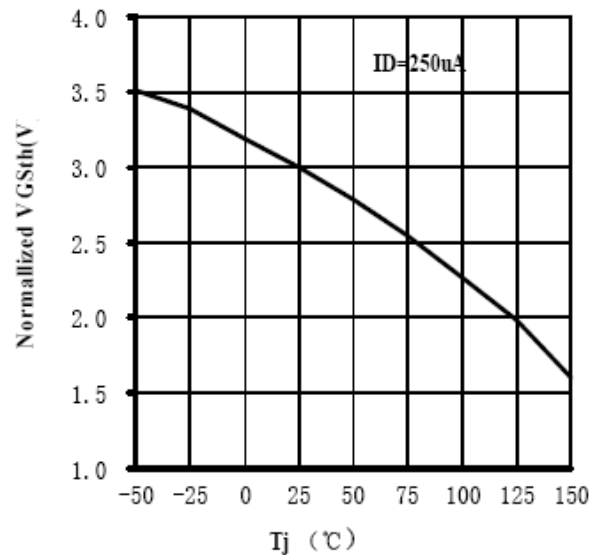

Figure 5. R_{DS(on)} vs. Drain Current Characteristics

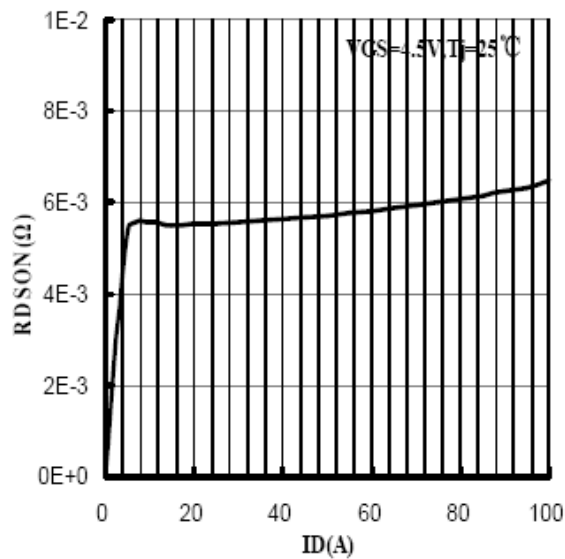

Figure 6. R_{DS(on)} vs. Junction Temperature Characteristics

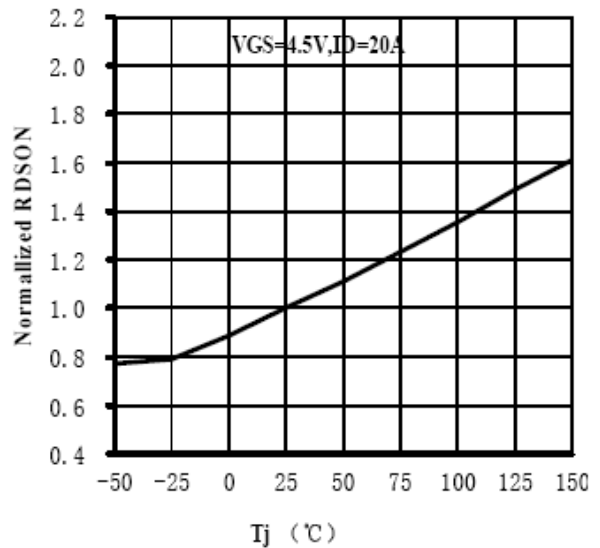

Figure 7. R_{DS(on)} vs. V_{GS} Characteristics

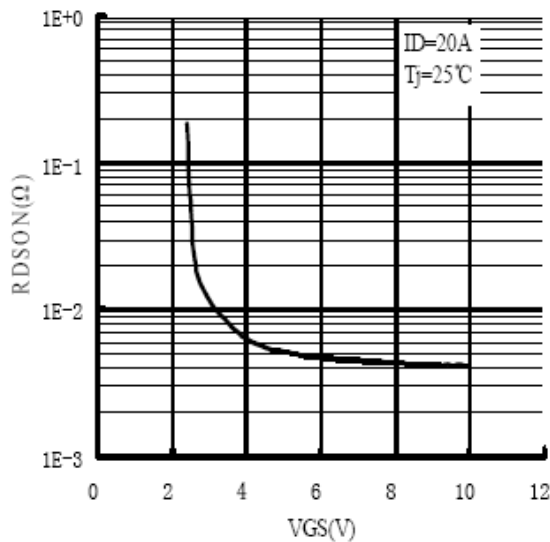

Figure 8. I_S vs. V_{SD} Characteristics

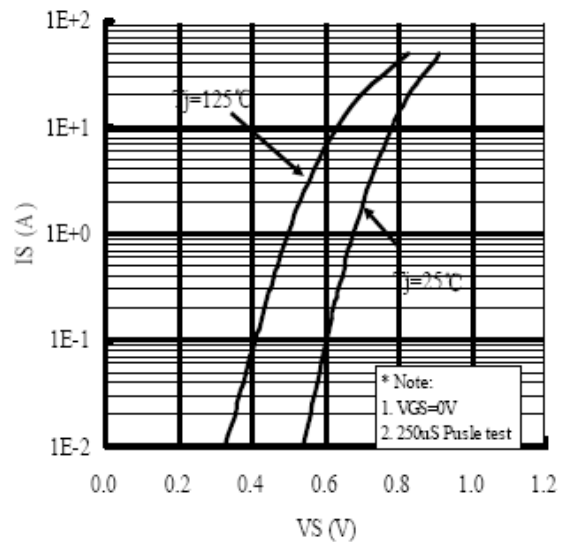

Figure 9. Gate Charge Characteristics

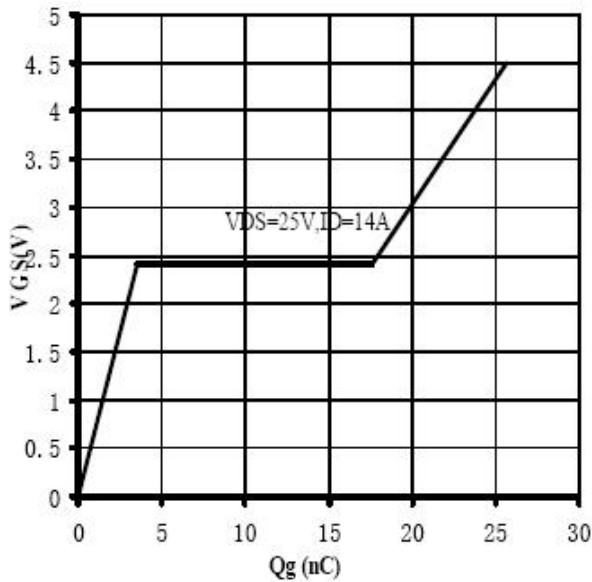

Figure 10. Capacitance Characteristics

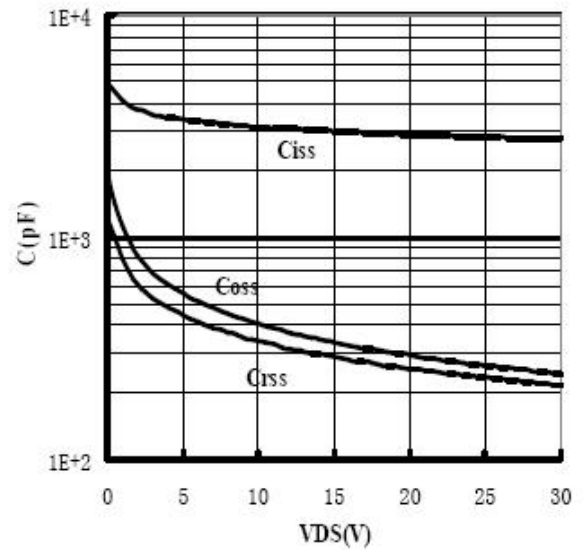
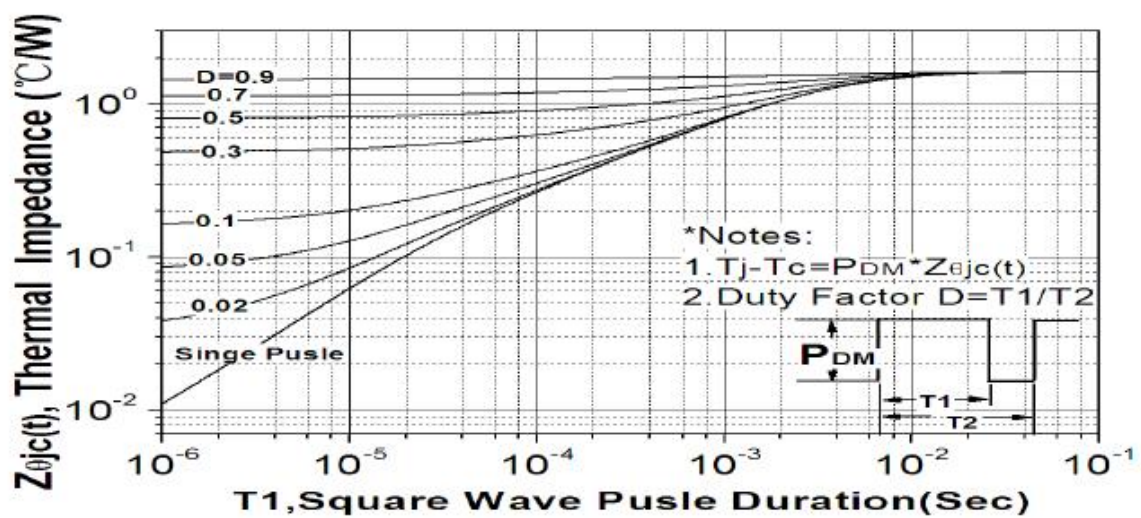
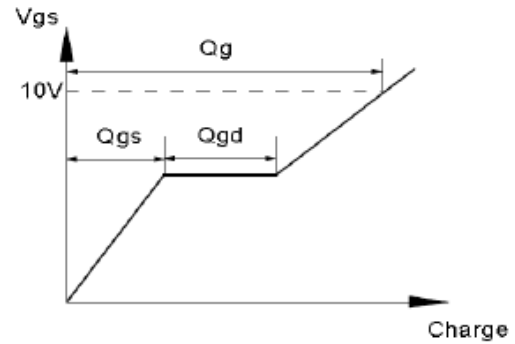
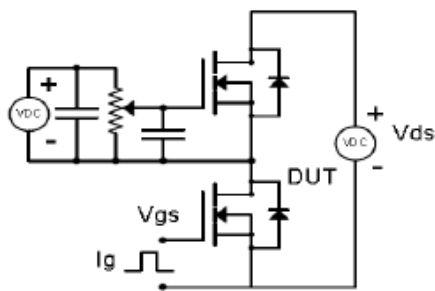

Figure 11. Thermal Resistance Characteristics



Gate Charge Test Circuit & Waveform



Resistive Switching Test Circuit & Waveforms

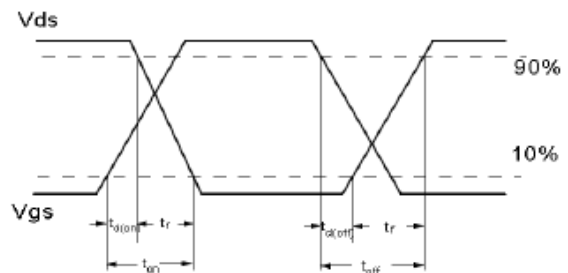
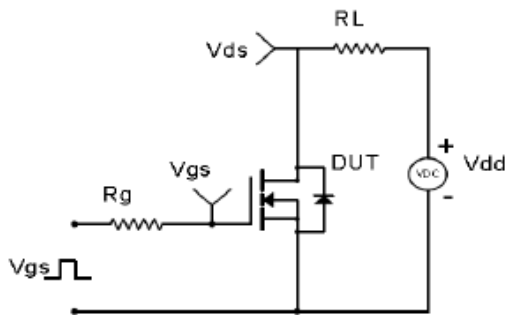

Unclamped Inductive Switching (UIS) Test Circuit & Waveforms

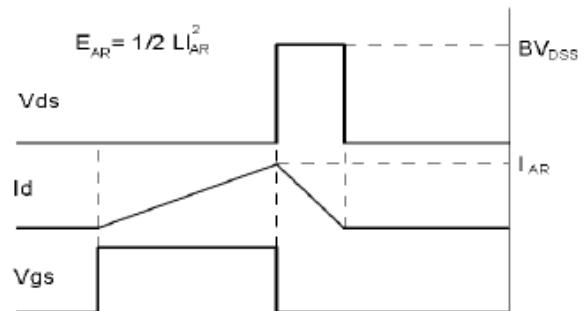
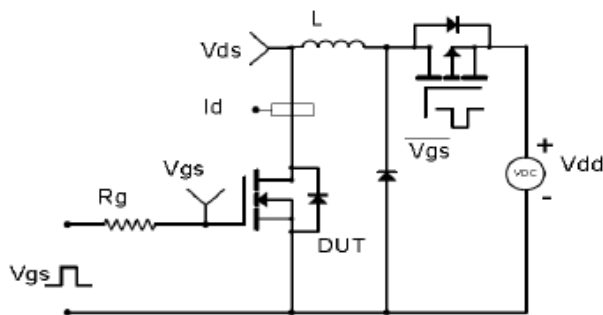

Diode Recovery Test Circuit & Waveforms

