

1. Features

- n $R_{DS(on)}=77m\Omega$ @ $V_{GS}=10V$
- n Super low gate charge
- n Green device available
- n Excellent Cdv/dt effect decline
- n Advanced high cell density trench technology

2. Description

The KIA7115A is the highest performance trenched N-ch MOSFETs with extreme high cell density, which provide excellent RDSON and gate charge for most of the synchronous buck converter applications. The KIA7115A meet the RoHs and Green Product requirement, 100% EAS guaranteed with full function reliability approved.

3. Symbol

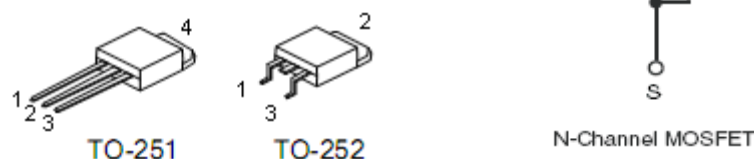

4. Absolute maximum ratings

($T_A=25^{\circ}C$, unless otherwise noted)

Parameter	Symbol	Rating	Units
Drain-source voltage	V_{DSS}	150	V
Gate-source voltage	V_{GS}	± 20	V
Continuous drain current $V_{GS}@10V^1$	I_D	$T_C=25^{\circ}C$	20
		$T_C=100^{\circ}C$	14
		$T_A=25^{\circ}C$	3
		$T_A=70^{\circ}C$	2.5
Pulsed drain current ²	I_{DM}	40	A
Single pulse avalanche energy ³	EAS	53	mJ
Avalanche current	I_{AS}	18	A
Total power dissipation ³	P_D	$T_C=25^{\circ}C$	72.6
		$T_A=25^{\circ}C$	2.1
Junction and storage temperature range	T_J, T_{STG}	-55 to 150	$^{\circ}C$
Thermal resistance-junction to ambient ¹	$R_{\theta JA}$	60	$^{\circ}C/W$
Thermal resistance-junction to case ¹	$R_{\theta JC}$	1.72	$^{\circ}C/W$

5. Electrical characteristics

($T_J=25^{\circ}\text{C}$, unless otherwise noted)

Parameter	Symbol	Test Conditions	Min	Typ	Max	Units
Drain-Source breakdown voltage	BV_{DSS}	$V_{GS}=0V, I_D=-250\mu A$	150	-	-	V
Drain-Source Leakage Current	I_{DSS}	$V_{DS}=120V, V_{GS}=0V,$ $T_J=25^{\circ}\text{C}$	-	-	1	μA
		$V_{DS}=120V, V_{GS}=0V,$ $T_J=55^{\circ}\text{C}$	-	-	5	
Gate-source leakage current	I_{GSS}	$V_{GS}=\pm 20V, V_{DS}=0V$	-	-	± 100	nA
Gate threshold voltage	$V_{GS(th)}$	$V_{DS}=V_{GS}, I_D=250\mu A$	1.2	-	2.5	V
Static drain-source on- resistance ²	$R_{DS(on)}$	$V_{GS}=10V, I_D=10A$	-	77	88	m Ω
		$V_{GS}=4.5V, I_D=10A$	-	82	100	
Forward transconductance	g_{FS}	$V_{DS}=5V, I_D=10A$	-	33	-	S
Total gate charge(10V)	Q_g	$V_{DS}=75V, V_{GS}=4.5V$ $I_D=10A$	-	25.1	-	nC
Gate-source charge	Q_{gs}		-	6.8	-	
Gate-drain charge	Q_{gd}		-	12.6	-	
Turn-on delay time	$t_{d(on)}$	$V_{DD}=75V,$ $R_G=3.3\Omega, V_{GS}=10V$ $I_D=10A$	-	13	-	ns
Rise time	t_r		-	8.2	-	
Turn-off delay time	$t_{d(off)}$		-	25	-	
Fall time	t_f		-	11	-	
Input capacitance	C_{iss}	$V_{GS}=0V, V_{DS}=25V$ $F=1.0\text{MHZ}$	-	2285	-	pF
Output capacitance	C_{oss}		-	110	-	
Reverse transfer capacitance	C_{rss}		-	83	-	
Diode characteristics						
Continuous source current ^{1,5}	I_S	$V_G=V_D=0V, \text{Force}$ current	-	-	20	A
Pulsed source current ^{2,5}	I_{SM}		-	-	40	A
Diode forward voltage ²	V_{SD}	$V_{GS}=0V, I_S=-1A,$ $T_J=25^{\circ}\text{C}$	-	-	1.2	V
Reverse recovery time	t_{rr}	$I_F=10A, di/dt=100A/us,$ $T_J=25^{\circ}\text{C}$	-	37	-	nS
Reverse recovery charge	Q_{rr}		-	263	-	nC

Note:1. The data tested by surface mounted on a 1 inch² FR-4 board with 2OZ copper.

2. The data tested by pulsed, pulse width $\leq 300\mu s$, duty cycle $\leq 2\%$.

3. The EAS data shows Max.rating. The test condition is $V_{DD}=25V, V_{GS}=10V, L=0.3mH, I_{AS}=18A$.

4. The power dissipation is limited by 150 °C junction temperature.

5. The data is theoretically the same as I_D and I_{DM} , in real applications, should be limited by total power dissipation.

6. Test circuits

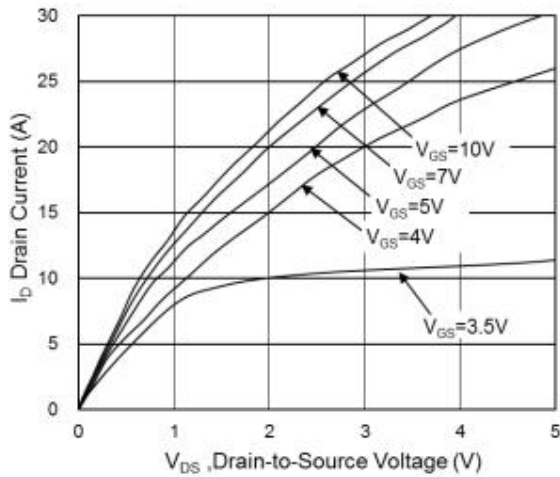

Fig.1 Typical Output Characteristics

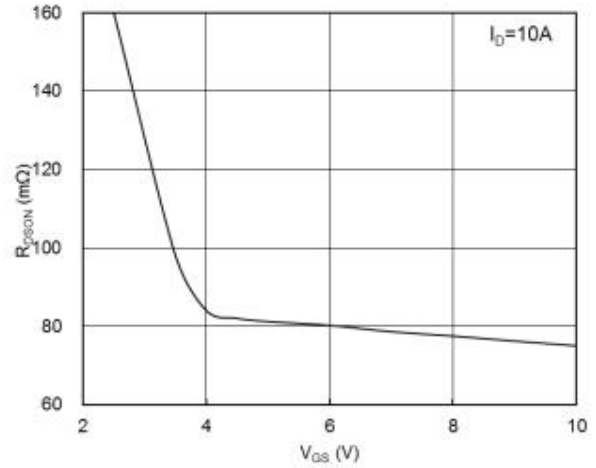

Fig.2 On-Resistance vs. Gate-Source Voltage

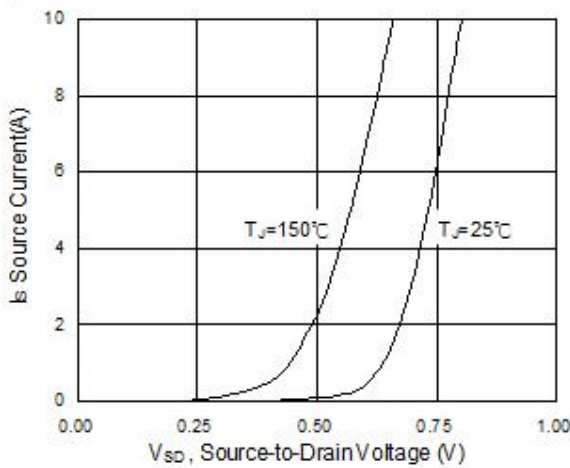

Fig.3 Forward Characteristics of Reverse

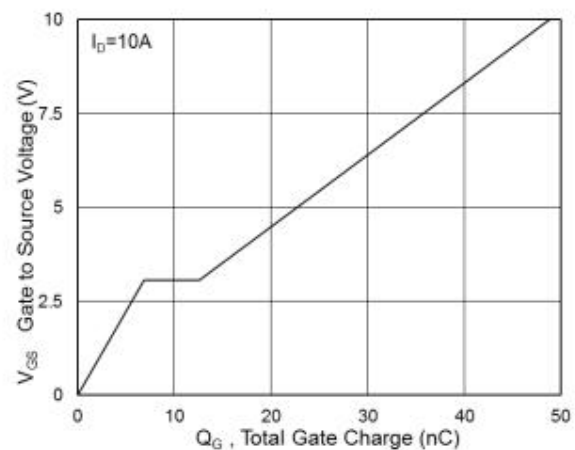

Fig.4 Gate-Charge Characteristics

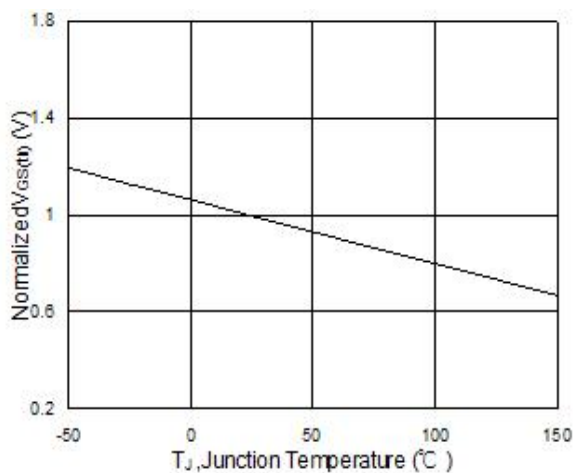

Fig.5 Normalized $V_{GS(th)}$ vs. T_J

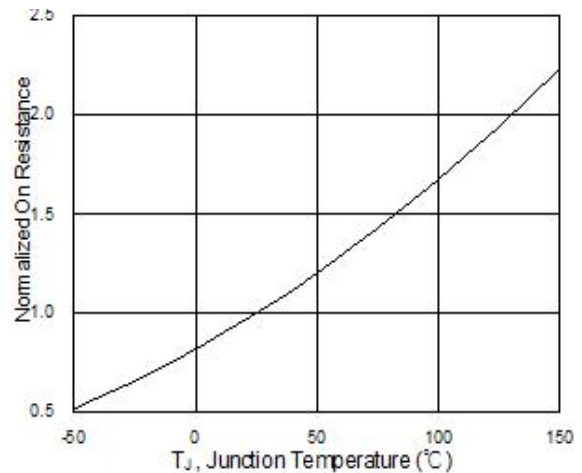

Fig.6 Normalized $R_{DS(on)}$ vs. T_J

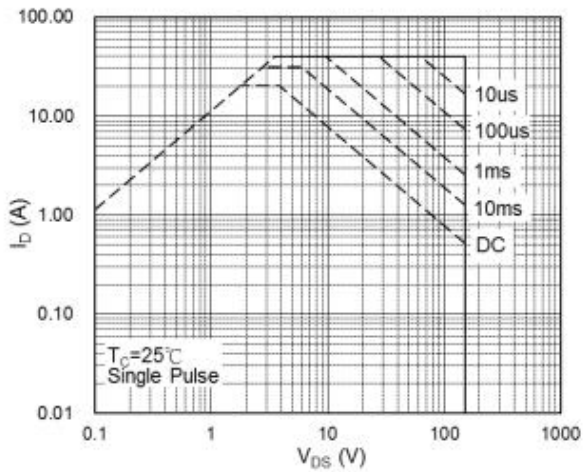

Fig.7 Capacitance

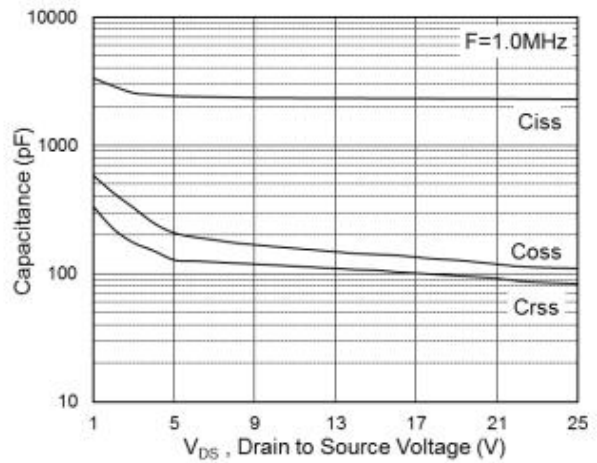

Fig.8 Safe Operating Area

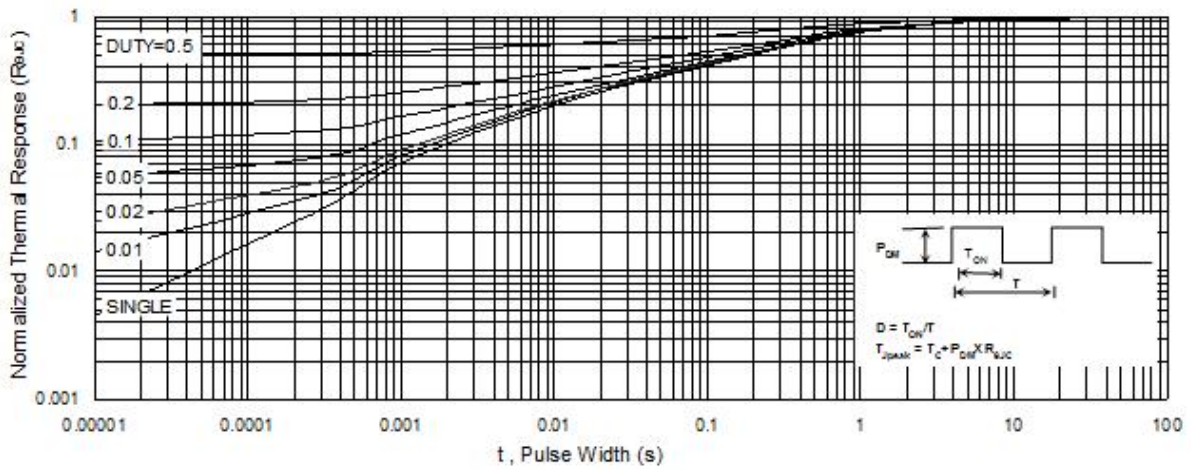

Fig.9 Normalized Maximum Transient Thermal Impedance

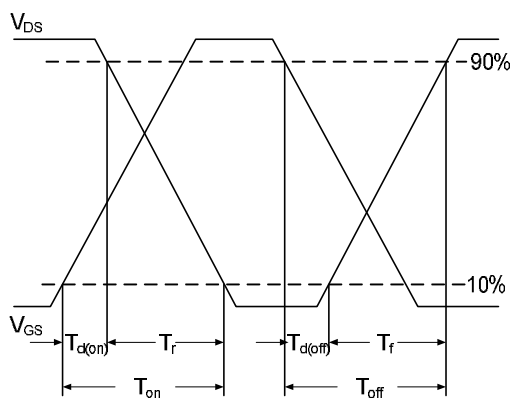

Fig.10 Switching Time Waveform

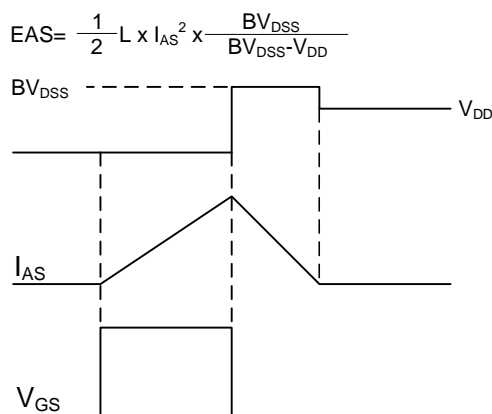

Fig.11 Unclamped Inductive Switching Waveform